

SFP6301TVX



Category	60cm
Product Family	Oven
Power supply	Electric
Heat source	ELECTRICITY
Cooking method	Thermo-ventilated
Cleaning system	Pyrolitic
EAN code	8017709282189



Aesthetics

Aesthetic	Classica	Serigraphy type	Symbols
Colour	Stainless steel	Door	With 2 horizontal strips
Finishing	Fingerproof	Handle	Classic
Design	Flat	Handle Colour	Inox
Material	Stainless steel	Logo	Embossed
Type of steel	Brushed	Control knobs	Classic
Glass Type	Eclipse	Controls colour	Steel effect
Serigraphy colour	Black		

Controls













Display name	CompactScreen	Control setting	Knobs
Display technology	LCD	No. of controls	2

Programs / Functions main oven

No. of cooking functions	10
---------------------------------	----

Traditional cooking functions

 Static	 Fan assisted	 Circulaire
 Turbo	 Eco	 Large grill
 Fan grill (large)	 Base	 Circulaire + bottom
 Pizza		

Other functions

 Defrost by time	 Leavening	 Sabbath
--	---	---

Cleaning functions

 Pirólisis
--

Options



Time-setting options	Delay start and automatic end cooking
Minute minder	Yes
Timer	1
Controls Lock / Child Safety	Yes

Other options	Keep warm
Showroom demo option	Yes
Rapid pre-heating	Yes

Technical Features



Minimum Temperature	30 °C	Door opening type	Standard opening
Maximum temperature	280 °C	Door	Cool
No. of shelves	5	Removable door	Yes
N. of fans	1	Full glass inner door	Yes
No. of lights	1	Removable inner door	Yes
Light type	Halogen	Total no. of door glasses	4
User-replaceable light	Yes	Cooling system	Tangential
Light Power	40 W	Cooling duct	Double
Light when door is opened	Yes	Speed Reduction Cooling System	Yes
Lower heating element power	1200 W	Door Lock During Pyrolysis	Yes
Grill element - power	1800 W	Usable cavity space dimensions (HxWxD)	360x444x425 mm
Circular heating element - Power	2000 W	Temperature control	Electronic
Heating suspended when door is opened	Yes	Cavity material	Ever clean Enamel

Performance / Energy Label



Energy efficiency class	A+	Energy consumption in forced air convection	2.45 MJ
Net volume of the cavity	70 l	Energy consumption per cycle in fan-forced convection	0.68 kWh
Energy consumption per cycle in conventional mode	1.09 kWh	Number of cavities	1
Energy consumption in conventional mode	3.92 MJ	Energy efficiency index	81 %

Accessories Included

Rack with back and side stop	1	Insert grid	1
Enamelled deep tray (40mm)	1		

Electrical Connection

Plug	Not present	Nominal power	3000 W
Voltage	220-240 V	Frequency (Hz)	50/60 Hz
Current	13 A	Power supply cable length	150 cm

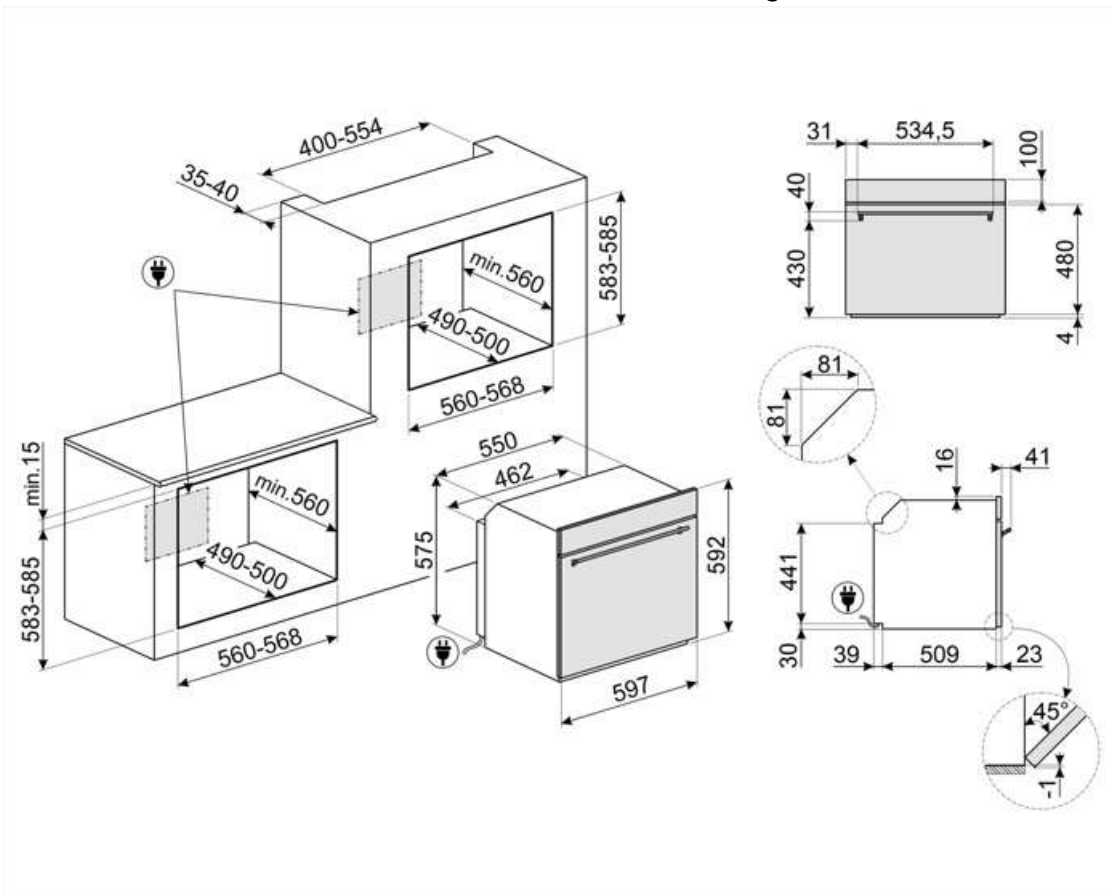

Not included accessories

GTP

Partially extractable telescopic guides (1 level), suitable for traditional ovens. Made in stainless steel, they guarantee stability and facilitate the smooth extraction of the trays.



PRTX

Refractory pizza stone with handles. D=35cm Not suitable for microwave ovens. Suitable for gas ovens, to be put on the griddle.



PALPZ

Pizza shovel with folding handle. Dimensions L31.5 x H32.5 cm. Easy and convenient to use and store. Perfect for serving pizza, bread and savory pastries in a safe and professional way.



BN640

Enamelled tray suitable for 45cm and 60cm ovens. Depth 540 mm. Perfect for cooking and roasting meat and fish in sauces. Also ideal for experimenting with lighter and crunchy side dishes



PR3845X

Antifingerprint stainless steel. Cover for furniture in column installation of more ovens



BN620-1

Enamelled tray suitable for 45cm and 60cm ovens. Depth 20 mm. Perfect for a wide range of savoury and sweet baking.

































GTT

Totally extractable telescopic guides (1 level), suitable for traditional ovens. Made in stainless steel, they guarantee stability and facilitate the smooth extraction of the trays.



Symbols glossary (TT)

 <p>Child lock: some models are fitted with a device to lock the programme/cycle so it cannot be accidentally changed.</p>	 <p>A+: Energy efficiency class A+ helps to save up to 10% energy compared to class A. Maximum performance with minimum consumption is guaranteed.</p>
 <p>Air cooling system: to ensure a safe surface temperatures.</p>	 <p>Defrost by time: Manual defrost function. At the end of the set duration, the function stops.</p>
 <p>Quadruple glazed: Number of glazed doors.</p>	 <p>Electric</p>
 <p>Ever Clean Enamel: Ever Clean enamel is applied electrostatically, corner to corner and edge to edge to prevent cracking or cracks over time. It is a particular pyrolytic enamel, resistant to acids which, in addition to being pleasantly bright, promotes greater cleaning of the oven walls, thanks to its lower porosity. It is baked at over 850 ° C and slowly polymerized at a scientifically determined rate to ensure uniform depth and strength Ever Clean enamel creates an impeccable finish both on the inside of the oven and on the trays, making the surfaces of the oven incredibly easy to maintain over time as it reduces the adhesion of fat during cooking</p>	 <p>Fresh Touch: Most of Smeg ovens have a "cool door." Thanks to the combination of tangential cooling and internal heat-reflecting glasses, the temperature on the outer surface of the door is maintained below 50° C. In addition to providing safety, this system protects the sides of the furniture from overheating by the oven.</p>
 <p>Fan assisted: Intense and homogeneous traditional cooking, also suitable for complex recipes. The fan is active and the heat comes from below and from above at the same time. Ventilated cooking ensures a faster and more homogeneous result, leaving fragrant foods outside and moister inside. Ideal for baked pasta, biscuits, roasts and cobblers.</p>	 <p>Static: Traditional cooking suitable for the preparation of one dish at a time. The fan is not active and the heat comes from below and from above at the same time. Static cooking is slower and more delicate, ideal in order to get well cooked and dry dishes even inside. Ideal for cooking all types of roasts, fatty meats, bread, filled cakes.</p>
 <p>Base: the heat comes only from the bottom of the cavity. The fan is not active. Ideal for sweet and savory pies, cobblers and pizzas. Designed to complete cooking and make food more crunchy This symbol in gas ovens indicates the gas burner.</p>	 <p>Circulaire with lower element: The addition of the lower element adds extra heat at the base for food which requires extra cooking.</p>
 <p>Circulaire: it is the perfect function for cooking all types of dishes in a more delicate way. The heat comes from the back of the oven and is distributed quickly and evenly The fan is active. It is also ideal for cooking on multiple levels without mixing smells and flavors.</p>	 <p>ECO: low energy consumption cooking: this function is particularly suitable for cooking on a single shelf with low energy consumption. It is recommended for all types of food except those that can generate a lot of moisture (for example vegetables). To achieve maximum energy savings and reduce time, it is recommended to put the food in the oven without preheating the cooking compartment</p>
 <p>Grill: Very intense heat coming only from above from a double heating element. The fan is not active. Provides excellent grilling and gratinating results. Used at the end of cooking, it gives a uniform browning to dishes.</p>	 <p>Fan grill: very intense heat coming only from above from a double heating element The fan is active. It allows the optimal grilling of thickest meats. Ideal for large cuts of meat.</p>

-  **Pizza function:** Specific function for cooking pizza in a pan. It allows to obtain a pizza that is soft inside and crispy outside with the topping perfectly cooked, not dry and not burnt.
-  **All glass inner door:** All glass inner door, a single flat surface which is simple to keep clean.
-  **KEEP_WARM_72dpi**
-  **PYROLYSIS - AUTOMATIC CLEANING FUNCTION:** the oven heats up to a temperature approaching 500 ° C and chars grease and food residues into a fine ash that can be easily wiped off with a damp cloth. At such a high temperature, the door locks automatically for safety, while the temperature of the door remains controlled so it is safe to touch User adjustable function based on the level of dirt present in the oven.
-  **Rapid preheating:** cooking is preceded by the preheating phase which allows the cooking compartment to reach the set temperature. This option reduces the time by up to 50%.
-  **The oven cavity has 5 different cooking levels.**
-  **The capacity indicates the amount of usable space in the oven cavity in litres.**
-  **Turbo:** the heat comes from 3 directions: above, below and from the back of the oven The fan is active. It allows quick cooking, even on several shelves without mixing the aromas. Ideal for large volumes or foods that require intense cooking.
-  **The inner door glass:** can be removed with a few quick movements for cleaning.
-  **Side lights:** Two opposing side lights increase visibility inside the oven.
-  **Air at 40°C** provides the perfect environment for proving yeast type dough mixes. Simply select the function and place dough in the cavity for allotted
-  **SABBATH:** function that allows to cook food respecting Judaism's day of rest provisions.
-  **Electronic control:** Allows you to maintain temperature inside the oven with the precision 2-3 ° C. This enables to cook meals that are very sensitive to temperature changes, such as cakes, souffles, puddings.
-  **With a simple and intuitive interface, the COMPACTscreen** provides a pleasant user experience, thanks to the interaction with the knobs.